



techsystem

automatyka klimatyzacja wentylacja

▸ zapoznaj się z naszą ofertą

VA-7450 Electronic Terminal Unit Valve Actuator

Introduction

The VA-7450 Series provides incremental or proportional control in HVAC applications. The compact design of this actuator makes it suitable for installation in confined spaces, such as fan coil applications.

The VA-7450 series actuator is designed for field mounting onto VG4000 and VG5000 terminal unit valves (see pertinent bulletin).



**VA-7450 microprocessor-based actuator
with VG5000**

Features and Benefits

- | | |
|---|---|
| <input type="checkbox"/> Auto-commissioning | Simplifies installation because models require no adjustments in the field. |
| <input type="checkbox"/> Motor Time-out feature | Extends actuator life by reducing drive time and therefore motor wear. |
| <input type="checkbox"/> Compact design | Allows installation in confined spaces (fan coils, etc.). |
| <input type="checkbox"/> Can be mounted in situ | Simplifies installation; allows application flexibility. |
| <input type="checkbox"/> Periodic full cycle (anti-sticking) option | Keeps plug and seat clear of impurities. |
| <input type="checkbox"/> LED operating status display | Reduces the commissioning time and displays operating status. |
| <input type="checkbox"/> Selectable flow characteristic with VG4000 & VG5000 | Improves controllability. |

Ordering data

Item Code	Features
VA-7450-1001	<ul style="list-style-type: none"> Incremental control No anti-sticking cycle
VA-7452-1001	<ul style="list-style-type: none"> Proportional control Self-calibrating 0 to 10 VDC input signal Direct Acting Adjusted to produce modulating flow characteristic in combination with VG4000 & VG5000 series terminal unit valves. No anti-sticking cycle
VA-7452-9001	<ul style="list-style-type: none"> Proportional control Self-calibrating Selectable input signals for range splitting (0 to 10, 0 to 5, 5 to 10 VDC). Reversible Action Selectable combined flow characteristic in combination with VG series terminal unit valves Selectable Anti-sticking cycle

All actuators fitted with 1.5 m cable.

Models with other cable lengths are available on request.

Actuator combinations

The VA-7450 series electronic valve actuators are designed to be used with the VG4000 and VG5000 valve series. The ordering data for these valve bodies are as follows:

● **VG4000 series**
VG4 □ 0 □ C □



● **VG5000 series**
VG5 □ 0 □ C □

Please refer to the product bulletin “VG5000 Forged Brass Valves” and “VG4000 Cast Bronze Terminal Unit Valve” for complete ordering information.

Operation

Incremental model (VA-7450-1001)

See also VG4000 and VG5000 product bulletins for valve operation.

Red cable energised		Actuator stem extends
White cable energised		Actuator stem retracts

When the signal is applied to the blue and red wires, the actuator stem extends. When the signal is removed the actuator remains in position. If the signal remains applied to the red or to the white wire, the actuator will time out and shut off the motor after approximately 80 seconds.

When the signal is applied to the blue and white wires, the actuator stem retracts. When the signal is removed the actuator remains in position. If the signal remains applied to the blue or to the white wire, the actuator will time out and shut off the motor after approximately 80 seconds.

End of stroke Confirmation: When the signal is applied continuously in the same direction, the actuator turns on every 2 hours and drives in the signal direction for approximately 80 seconds to confirm the end of stroke position.

Proportional models (VA-7452-x001)

See also VG5000 product bulletin for valve operation.

VA-7452-1001 has fixed settings (see curve ① below) and the **VA-7452-9001** adjustable:

Action: When the signal increases in Direct Action (DA) configuration or decreases in Reverse Action (RA) configuration, the actuator motor drives the gear assembly, pushing down on the valve return spring.

When the signal decreases in DA configuration or increases in RA configuration, the actuator retracts and allows the valve return spring to move the valve stem in the direction of its normal position or up.

Jumper 5 “Direct Action” 

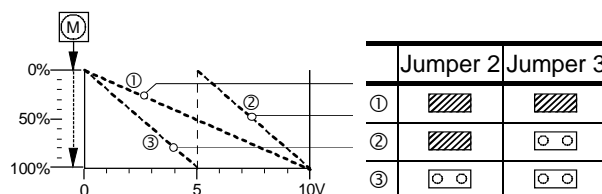

Jumper 5 “Reverse Action” 

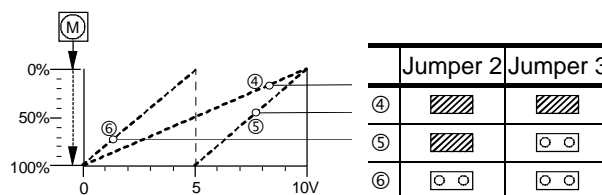

End of stroke confirmation: When the input signal is at 0 or 100% continuously, the actuator turns on every 2 hours and drives in the signal direction for approximately 80 seconds to confirm the end-of-stroke position.

Self-Calibration cycle: when the power is applied, the actuator self-calibrates to the full stroke end position by performing a complete cycle. The actuator drives in the stem down direction for approximately 80 seconds, then drives to the input signal command position.

Anti-Sticking Cycle (VA-7452-9001): When the anti-sticking cycle is enabled (ON), the actuator performs one complete cycle every 24 hours to clear possible accumulation of impurities from the valve plug and seat. The anti-sticking feature is selectable through jumper 1.

Combined flow characteristic: The actuator can be set to produce a modulating flow characteristic when used in combination with VG4000 and VG5000 valves series.

Selection of valve port type: the actuator is factory set for use with 2-way Push Down to Close (PDTC) VG4200 and VG5200 valves. For 2-way Push Down To Open (PDTO) VG4400 and VG5400 valve applications set the valve port selection jumper to PDTO. For 3-way VG4800 and VG5800 valve applications set the jumper to the valve port type that corresponds to the service port of the valve.

Operating display

LED Indication		
ON		Power supply present, motor not running. <ul style="list-style-type: none"> • Incremental actuators: time out • Proportional actuators: actuator is in control
Single Blinking		Motor is running
Double Blinking		Actuator performs an end-of-stroke confirmation cycle or an anti-sticking cycle
OFF		Power supply is not present

Valve Action Summary

See paragraph "Operation" for more information regarding actuator stem action.

Code	Type	Stem movement / flow	
		= flow	= no flow
VG42x0xC VG52x0xC	 2-way NO, PDTCT	Actuator stem down	Actuator stem up
VG44x0xC VG54x0xC	 2-way NC, PDTO	Actuator stem down	Actuator stem up
VG55x0xC	 Return Supply 3-way + NO ByPass	Actuator stem down	Actuator stem up
VG48x0xC VG58x0xC	 3-way, mixing	Actuator stem down	Actuator stem up

Mounting instructions

When mounting the actuator on a VG4000 or VG5000 valve, please follow the instructions below:

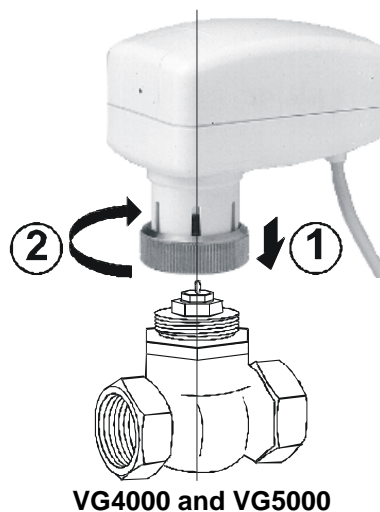

- Never use the actuator as a mounting lever.
- Mounting position:

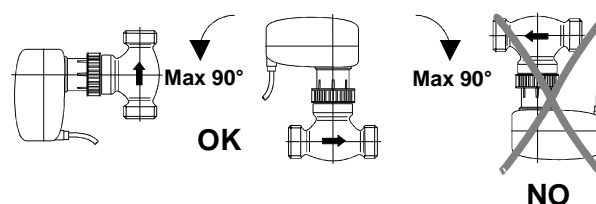

Wiring instructions

WARNING

When servicing make sure that:

- the electric supply to the actuator is switched off to avoid possible damage to the equipment, personal injury or shock.
- you do not touch or attempt to connect or disconnect wires when electric power is on.

When wiring the actuator, please follow the instructions below:

Before mounting, wiring or adjusting the actuator, make sure that the power supply has been disconnected to avoid possible harm to material or person.

Make sure that the line power supply is in accordance with the power supply specified on the actuator.

All wiring should conform to local codes and must be carried out by authorised personnel only.

Wiring Diagrams

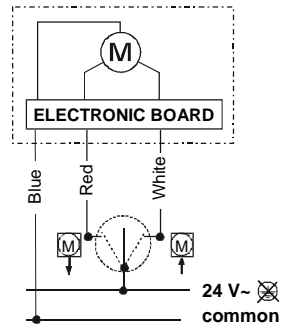

Incremental model

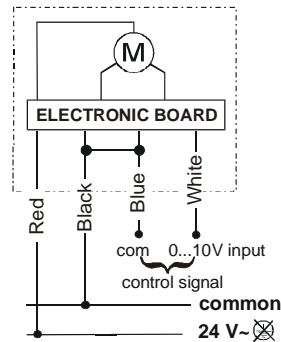

Proportional model

Adjustments (jumper settings) of proportional models

VA-7452-1001 has FIXED settings (the jumpers are NOT accessible)





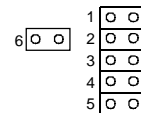







VA-7452-9001 is configurable

This is how the jumpers are positioned on the board:



Jumper in place: 

Jumper removed: 

Function	Jumper No.	VA-7452-9001 (adjustable)		VA-7452-1001 (fixed settings, not adjustable)
		Factory setting	Alternative setting	
Anti-sticking	1	 enabled	 disabled	not active
Input control signal	2	 0..10V	 5..10V  0..5V	0...10 V
	3			
Adjustable flow characteristic with VG4000 and VG5000	4	 Modulating with continuously increasing flow curve	 Modulating with flat increase in lower area of flow curve	Modulating with continuously increasing flow curve
Action	5	 Direct (DA)	 Reverse (RA)	Direct (DA)
Valve port type	6	 2-way PDT0 (NC) and 3-way Normally Closed port	 2-way PDT0 (NO) valve bodies	2-way PDT0 (NC) and 3-way Normally Closed port

With K_{vs} 0.25 and 0.4 combined flow characteristic is always “quick opening” independent of jumper setting.

Dimensions (in mm)

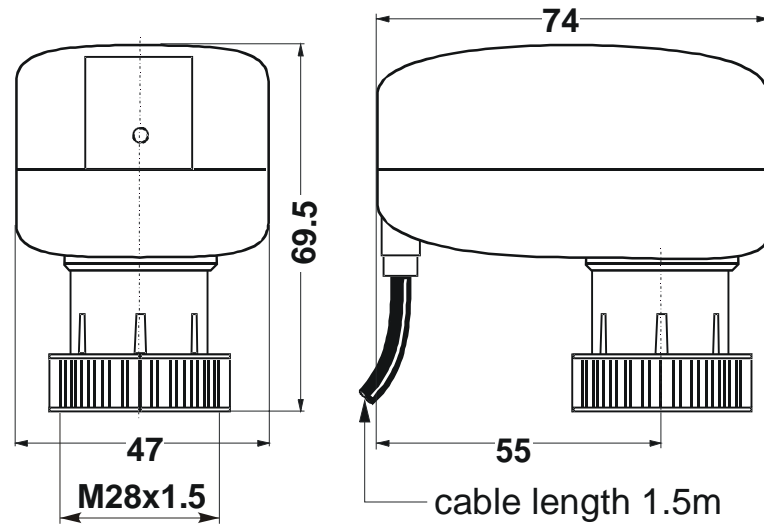

VA-7450 actuator

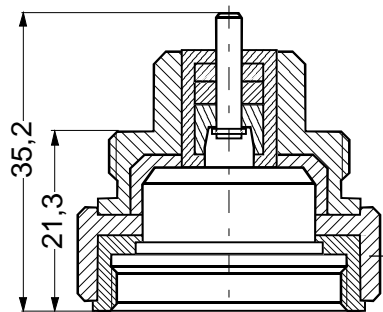

Manual Override

Turn approx. 90°
for max. stroke.

VA-7450-8900 manual override ring accessory (optional) for combination with VG4000 or VG5000 valve bodies.

It is used to manually open PDTO 2-Way valves or the Normally Closed port of 3-way valves. It is to be mounted between the valve and the actuator.

Note: The manual override ring will not fully close PDTC valves or the Normally Opened port of 3-way valves.

Specifications

Models	VA-7450-1001	VA-7452-1001: Fixed settings (not adjustable) VA-7452-9001: Adjustable
Action/Control	Incremental (floating or PAT)	Proportional (0...10 V, 0...5 V or 5...10 V)
Supply voltage (50/60 Hz)	24 VAC \pm 15%	
Input impedance	-	80 k Ω
Power consumption	Apparent: 2.7 VA at max. power supply Active: 2 W	
Nominal force	120 N +30% / -20%	
Maximum stroke	5 mm	
Full stroke time	45 seconds for 3 mm stroke	
Protection	IP40 (EN 60529)	
Material:		
Housing / Yoke	PA66 – Glass + Mineral filled (30% total) Kelon A FR CETG/300-V0	
Fitting	Brass CuZn40Pb2	
Fitting thread	M28x1.5	
Housing colour	RAL7035	
Ambient Operating condition	0°C to 50°C, non condensing	
Ambient Storage condition	-20°C to 65°C, non condensing	
Max. fluid temperature	95°C	
Electrical connections	1.5 m flexible cable, \varnothing 4.5 mm	
Operating status	LED display	
Audible Noise Rating	< 30 dB(A)	
Shipping Weight	0.15 Kg	
CE Compliance	Directive 89/336 EEC: EN 61000-6-1; EN 61000-6-3	

The performance specifications are nominal and conform to acceptable industry standards. For application at conditions beyond these specifications, consult the local Johnson Controls office. Johnson Controls, Inc. shall not be liable for damages resulting from misapplication or misuse of its products.



Johnson Controls International, Inc.

Headquarters:

European Customer Service Center:

European Factories:

Branch Offices

Milwaukee, Wisconsin, USA

Westendhof 3, D-45143 Essen, Germany

Essen (Germany), Leeuwarden (The Netherlands) and Lomagna (Italy)

Principal European Cities.