



techsystem

automatyka klimatyzacja wentylacja

▸ zapoznaj się z naszą ofertą

Series V46SA

Pressure Actuated “Low Flow” Water Regulating Valve

Introduction

The V46SA is a direct acting, “all range”, pressure actuated modulating valve, used to control the waterflow to a condenser by directly sensing pressure changes in a non-corrosive refrigerant circuit. The V46SA is specially designed for use on equipment requiring a low condenser waterflow such as icemakers, small heatpumps and watercoolers.

The springhousing and power element are rolled to the valve body. Rubber diaphragms seal the water away from the range spring and bellows part so these are not submerged in water where they would be subject to sedimentation and corrosion. The valve can be ordered style 5 (without capillary), style 13, style 34 and style 50 (incl. 75 cm capillary). The capillary part will be delivered separated from the valve.



**V46SA Pressure Actuated “Low Flow”
Water Regulating Valve**

Feature and Benefits	
<input type="checkbox"/> Valve designed for low flow.	Designed to prevent cavitation and water hammer at low water flow applications.
<input type="checkbox"/> “All range” power element and spring housing.	Reduces stock. Only one valve for all non-corrosive refrigerants.
<input type="checkbox"/> Small dimensions.	Easy to fit in “small dimension” equipment.
<input type="checkbox"/> Pressure actuated	Fast response to pressure increase.
<input type="checkbox"/> Various pressure connection styles.	Possibility to meet the legislation in your country.
<input type="checkbox"/> High refrigerant pressure resistant bellows.	Refrigerant pressure may increase up to 28 bar without bellow damage.

Note

All series V46 water regulating valves are designed for use only as operating devices. Where system closure, improper flow or loss of pressure due to valve failure can result in personal injury and/or loss of property, a separate pressure relief or safety shut off valve, as applicable must be added by the user.

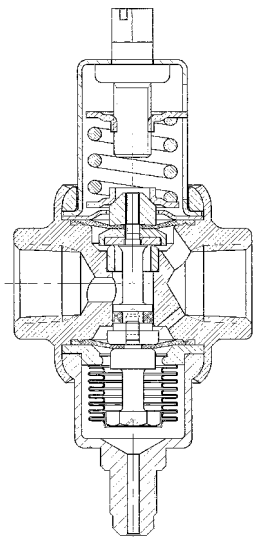

Fig. 1
Cross-Section of V46SA

Mounting

Style 5 valves may be mounted in any position. For capillary types it is recommended that the pressure connection be made below the mounting plane of the valve to minimize the possibility of slow response due to oil accumulating in the capillary.

Adjustment

The pressure at which the valve starts to open (opening point) can be adjusted by the adjusting screw located at the top of the spring housing. Clockwise will lower and counter clockwise will raise the opening point (Valve is not factory set at a certain value).

Valve Capacity

The valve capacity is determined by three data:

1. The required max. flow.
2. The max. allowed pressure drop across the valve (= Δp bar).
3. The head pressure rise which is the difference between the pressure where the valve starts to open and the condenser operating pressure (= HPR) .

The valve operating conditions can be determined by use of the flow diagram or K_v calculation formulae.

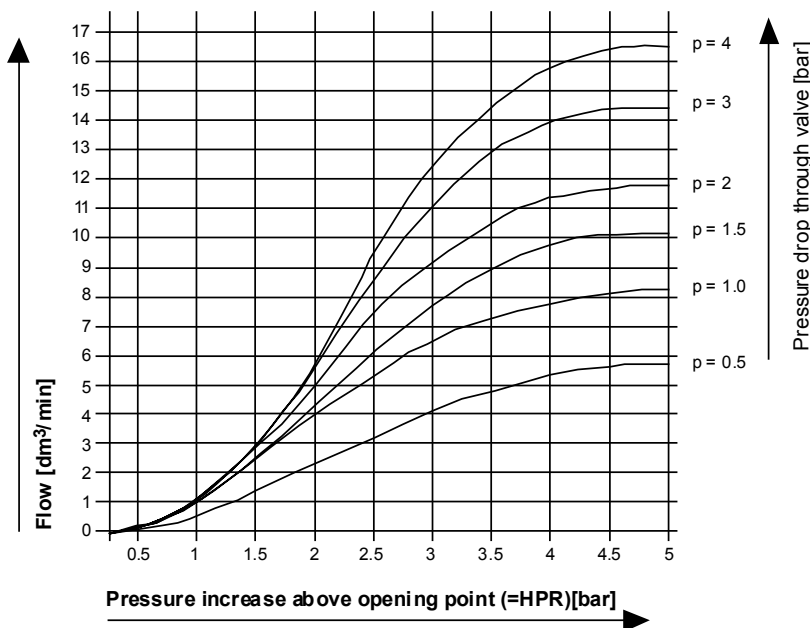

Fig. 2
Flow Diagram

For water the following formulae can be used to calculate the quantity of water (Q in m³/h) or the pressure drop across the valve (Δp in bar).

$$K_v = \frac{Q}{\sqrt{\Delta p}} \quad \Delta p = \left(\frac{Q}{K_v}\right)^2 \quad Q = K_v \cdot \sqrt{\Delta p}$$

The (V46SA) K_v -value= 0.5

The K_v factor is the quantity of 20°C water that will pass through the valve at one bar pressure drop and maximum valve opening.

Note

If the compressor operates in a high ambient temperature, the refrigerant pressure may at times remain high enough to cause the valve to partly open when the compressor is idle. In such conditions the valve opening point should be raised just enough to cause the valve to close during compressor standby periods. Take this into account when flow is calculated..

Pressure Connections

In the valve selection table the following connection styles are given.

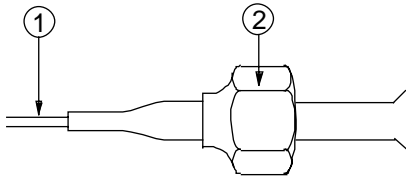

Fig. 3
Style 13 (excl. valve depressor)

1. 75 cm capillary
2. 7/16-20 UNF flare nut

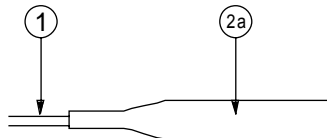

Fig. 4
Style 34

1. 75 cm capillary
2. 1/4" tube for braze connection

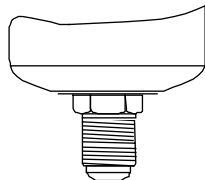

Fig. 5
Style 5
7/16-20 UNF

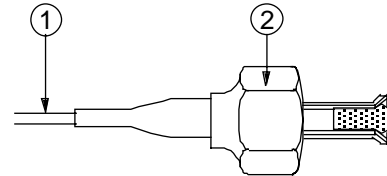

Fig. 6
Style 45A (incl. valve depressor mounted into flare)

1. 75 cm capillary.
2. 7/16 - 20 UNF flare nut.

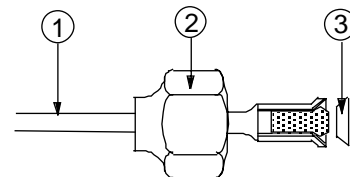

Fig. 7
Style 50 (incl. valve depressor mounted into machined flare)

1. 75 cm capillary.
2. 7/16 - 20 UNF flare nut.
3. copper sealing

Type Number Selection Table

V46SA-9101	75 cm capillary style 45A soldered to power element
V46SA-9110	75 cm capillary style 50 (separate)
V46SA-9300	Style 5
V46SA-9600	75 cm capillary style 13 (separate)
V46SA-9950	75 cm capillary style 34 (separate)
V46SA-9951	75 cm capillary style 34 soldered to power element

Repair and Replacement

Repair is not possible. In case of an improperly functioning control, please check with your nearest supplier. When contacting the supplier for a replacement you should state the type-model number which can be found on the data plate.

Dimensions

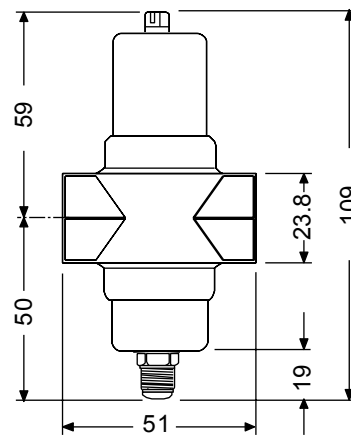

Fig. 7

Specifications

Size	3/8"
Control action	direct (open on pressure increase)
Operating pressure range	5-23 bar (non-corrosive refr.)
Max. refrig. overrun pressure	28 bar
Max. water pressure	23 bar
Operating water pressure max.	10 bar
Max. Δp across valve	6 bar
Max. water supply temp.	90°C
Min. water supply temp.	-20°C (care should be taken, the valve does not freeze up)
Valve hysteresis	≈ 2.5 bar at 10 bar setting
K_v value	0.5
Pipe connection	ISO 228 (ISO 228 = DIN 259-Rp = BSPP)
Pressure connections	Style 5 Style 13 incl. 75 cm capillary Style 50 incl. 75 cm capillary Style 34 incl. 75 cm capillary Style 45A incl. 75 cm capillary
Materials	body : brass seat : alum. bronze disc : BUNA-N disc cup : brass stem : brass diaphragms : BUNA-N bellows : phosphor bronze bellows cup : brass
Package	individual pack
Weight	0,45 kg

The performance specifications are nominal and conform to acceptable industry standards. For applications at conditions beyond these specifications, consult the local Johnson Controls office or representative. Johnson Controls shall not be liable for damages resulting from misapplication or misuse of its products.

**JOHNSON
CONTROLS**

Johnson Controls International, Inc.

Headquarters: Milwaukee, WI, USA
European Headquarters: Brussels, Belgium
European Factories: Lomagna (Italy), Leeuwarden (The Netherlands) and Essen (Germany)
Branch Offices: Principal European Cities.

This document is subject to change

www.johnsoncontrols.com
Printed in Europe

